

AUFBAUANLEITUNG

Assembly instruction

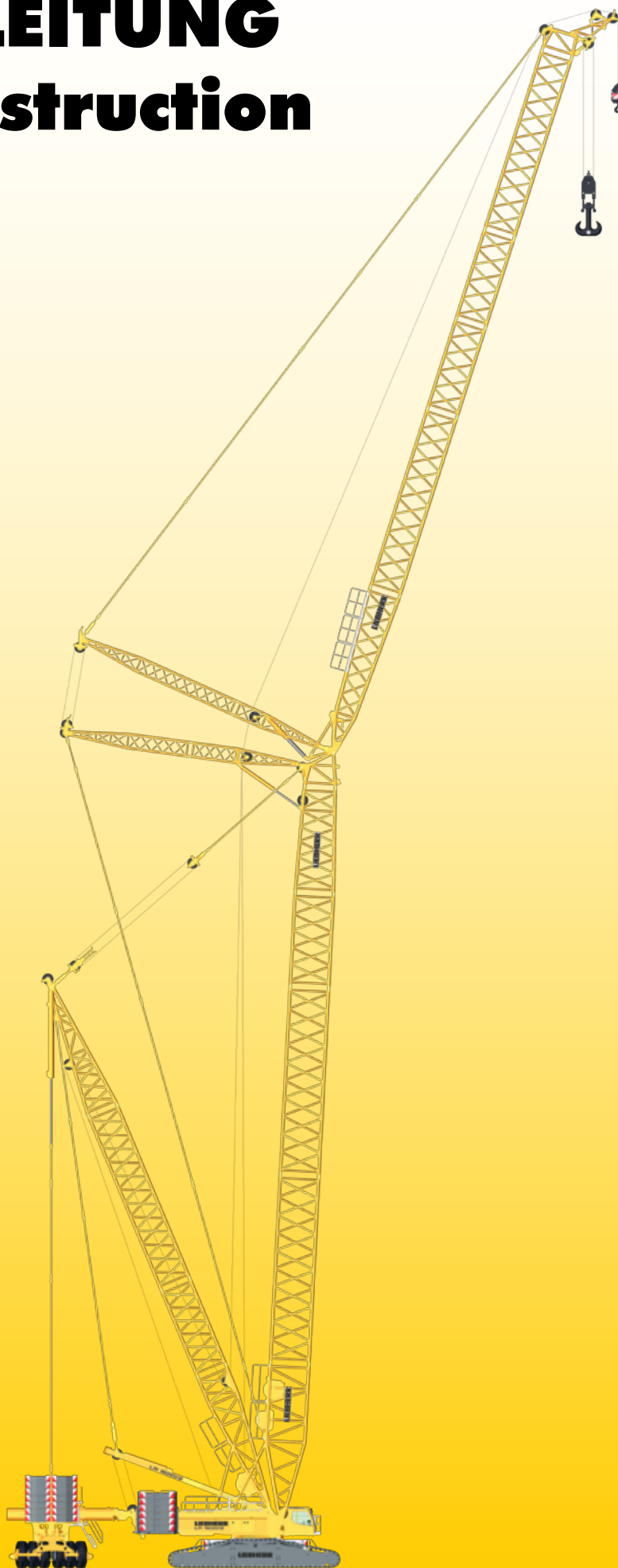

LR 1600/2

LIEBHERR

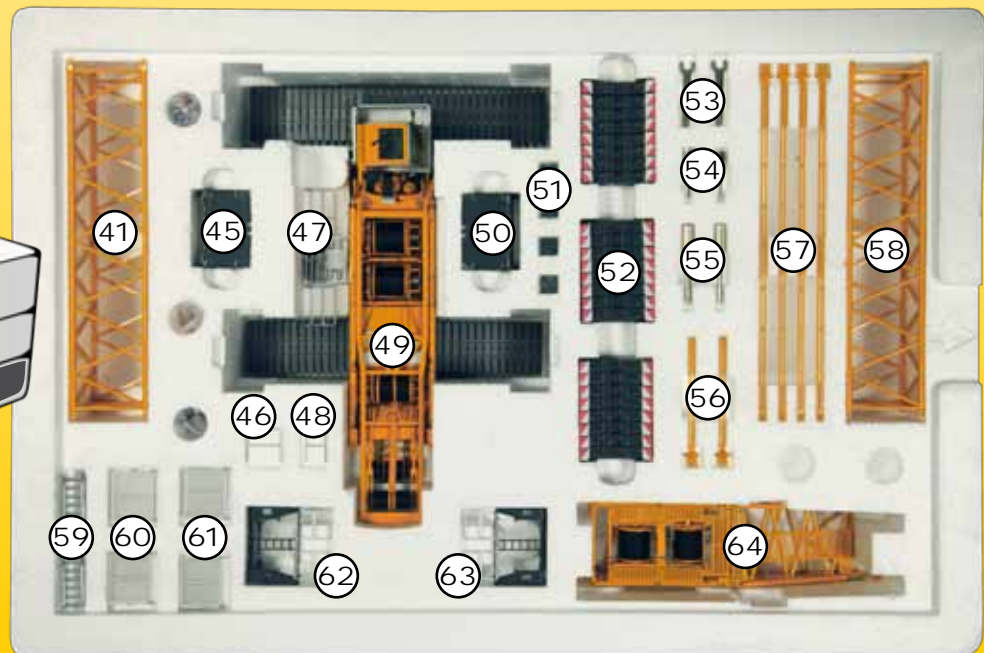
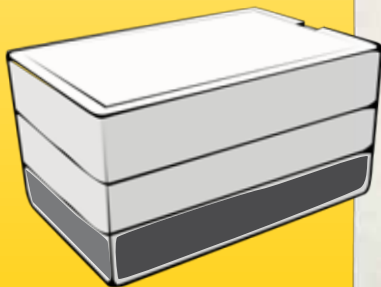
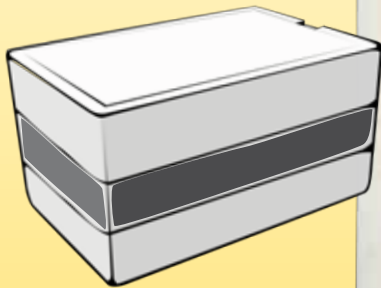
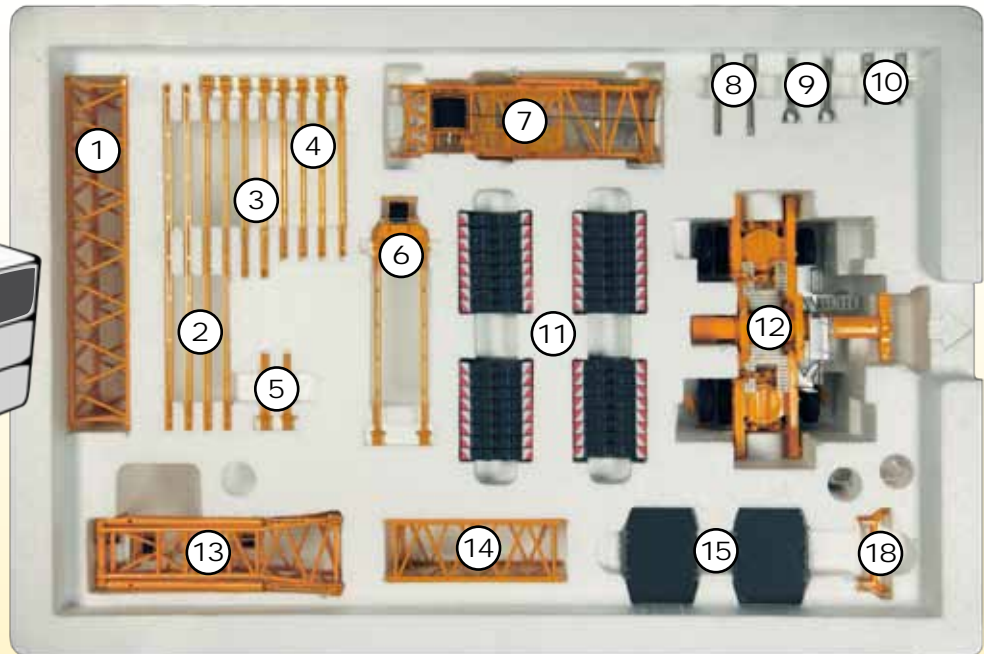
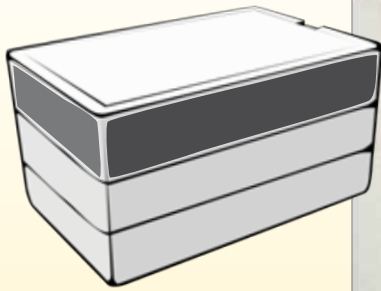



START

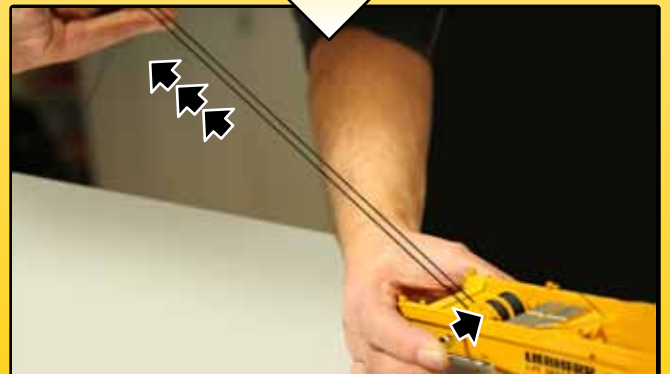
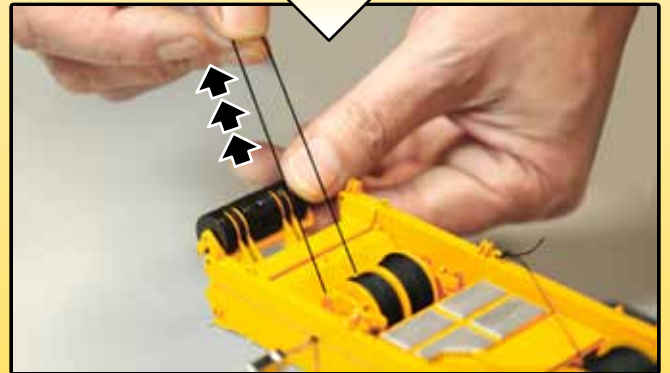
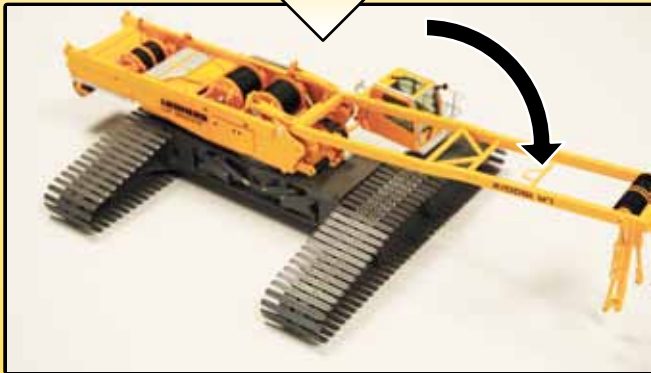
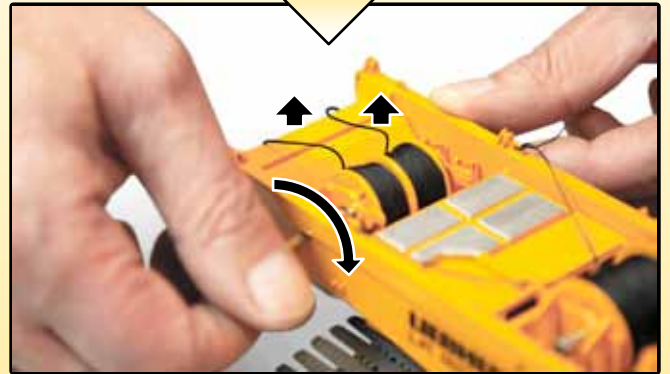
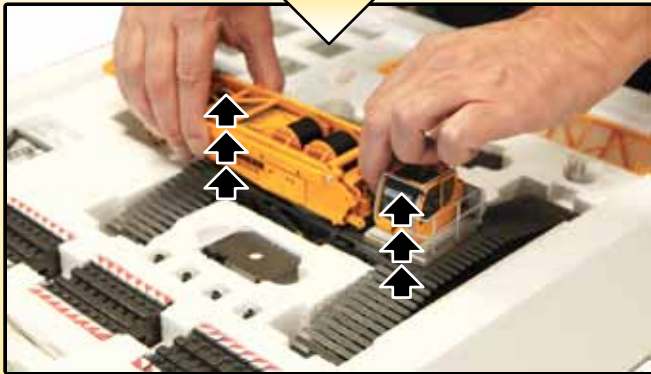

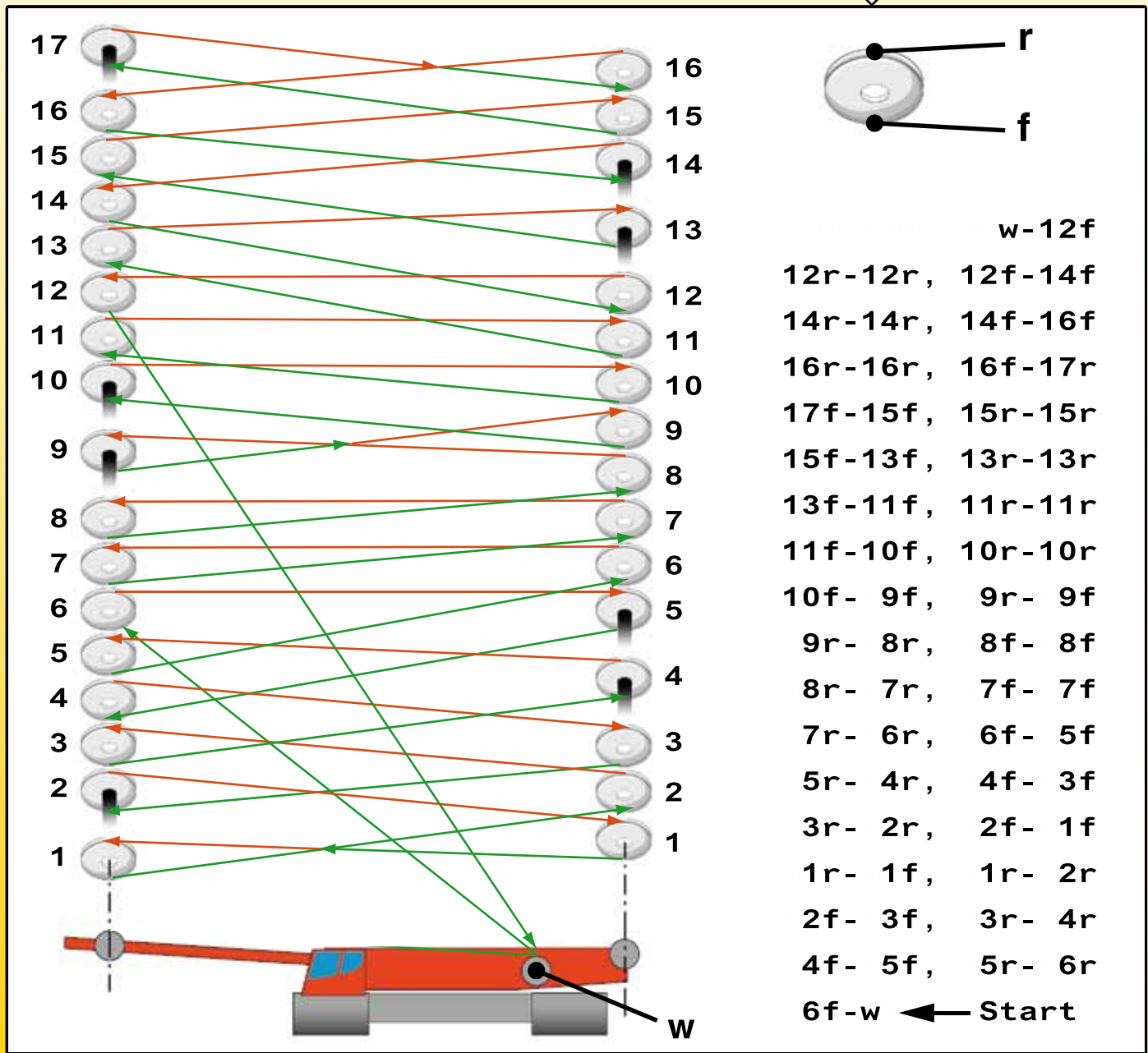
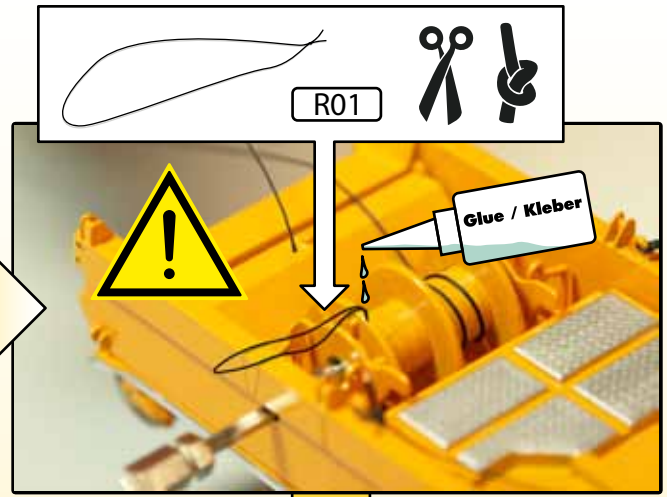
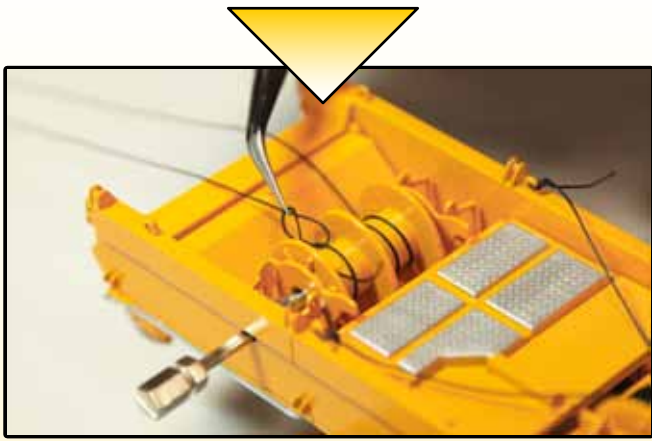

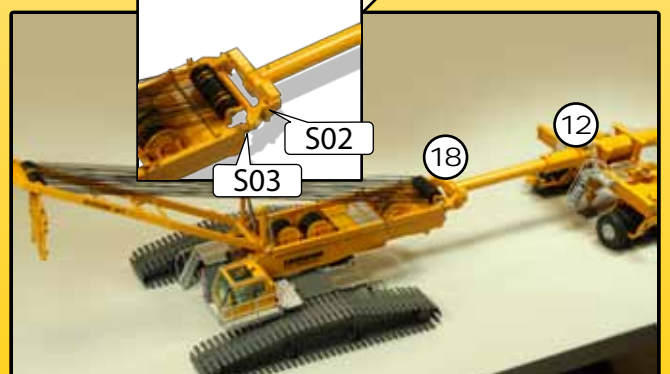
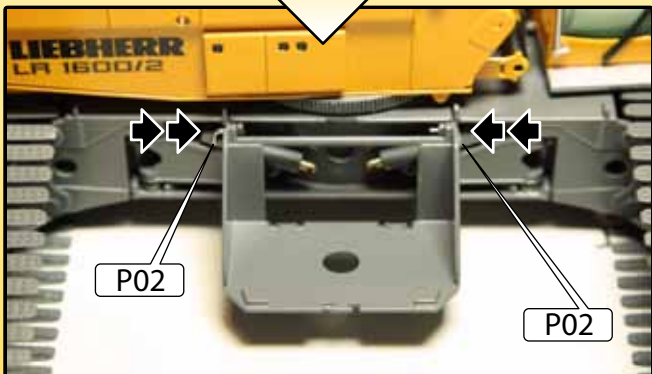
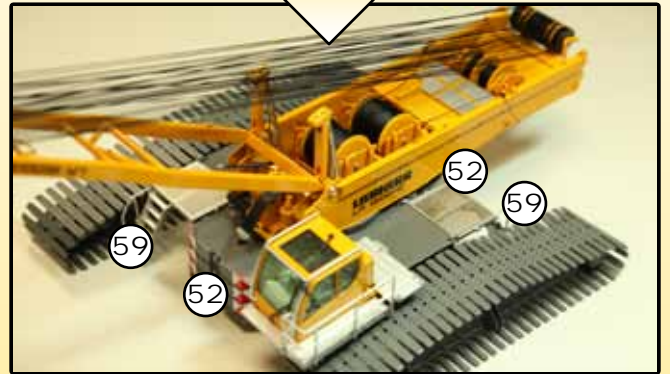
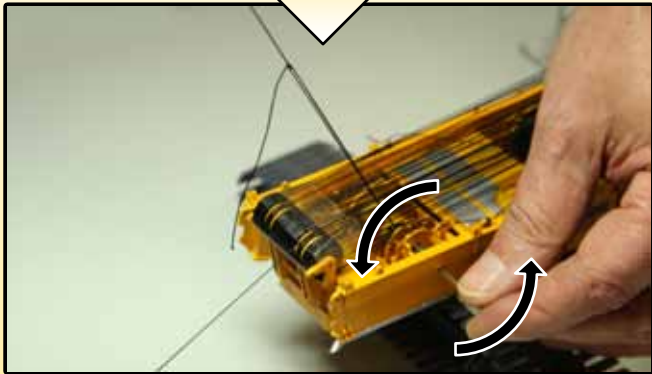
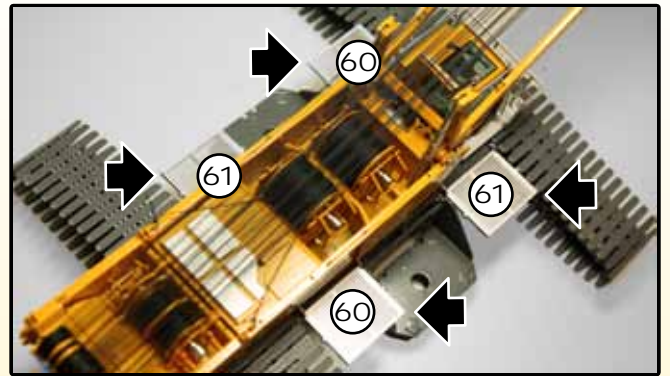
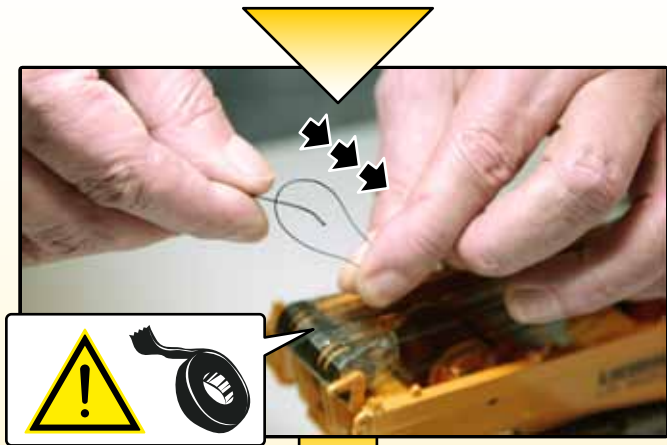

LR 1600/2

LIEBHERR

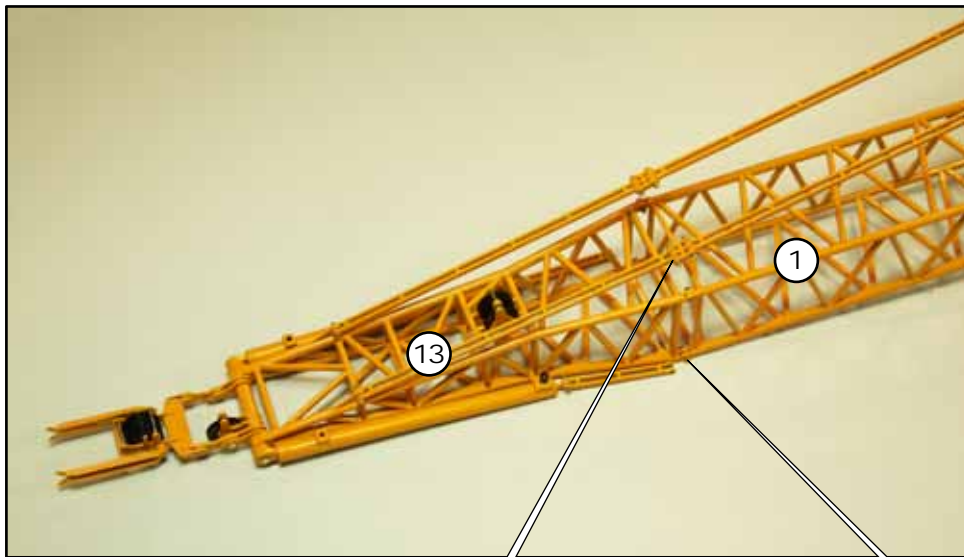
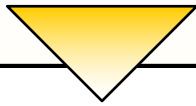

S02

S03



S04

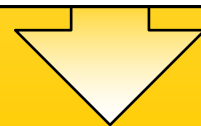

LR 1600/2

LIEBHERR

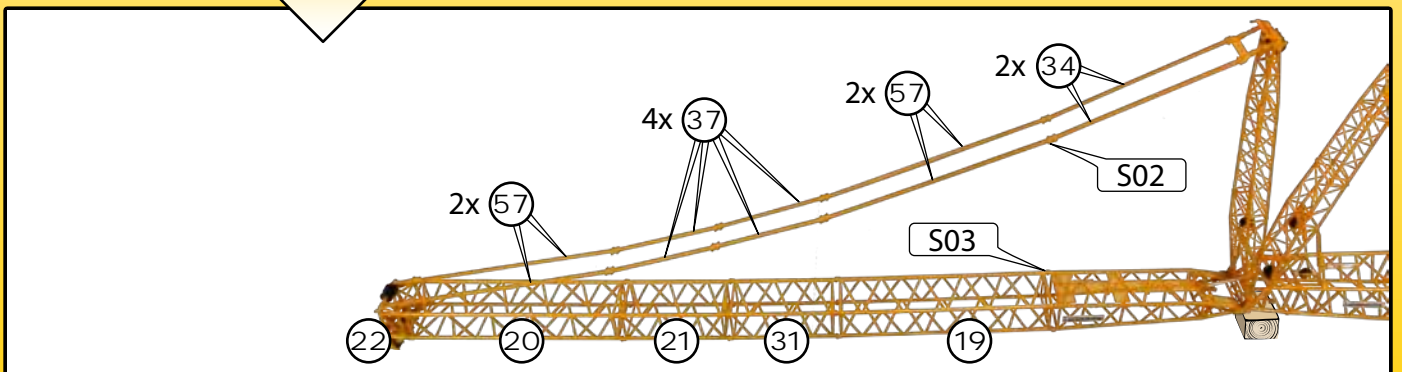
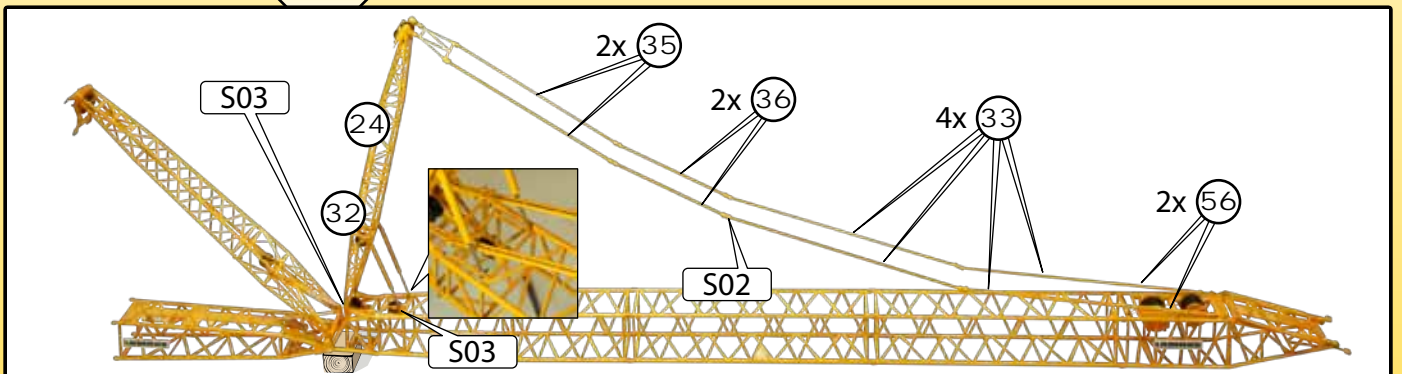
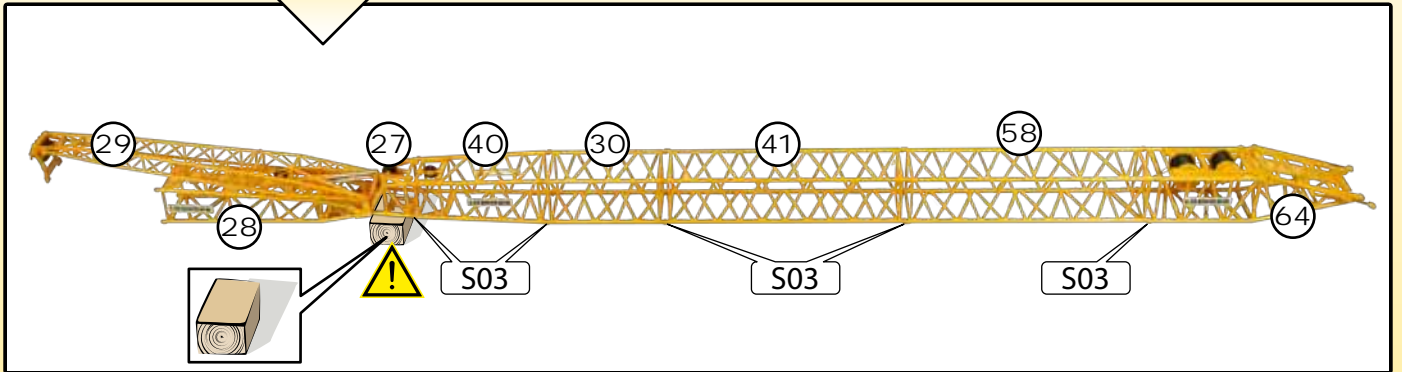
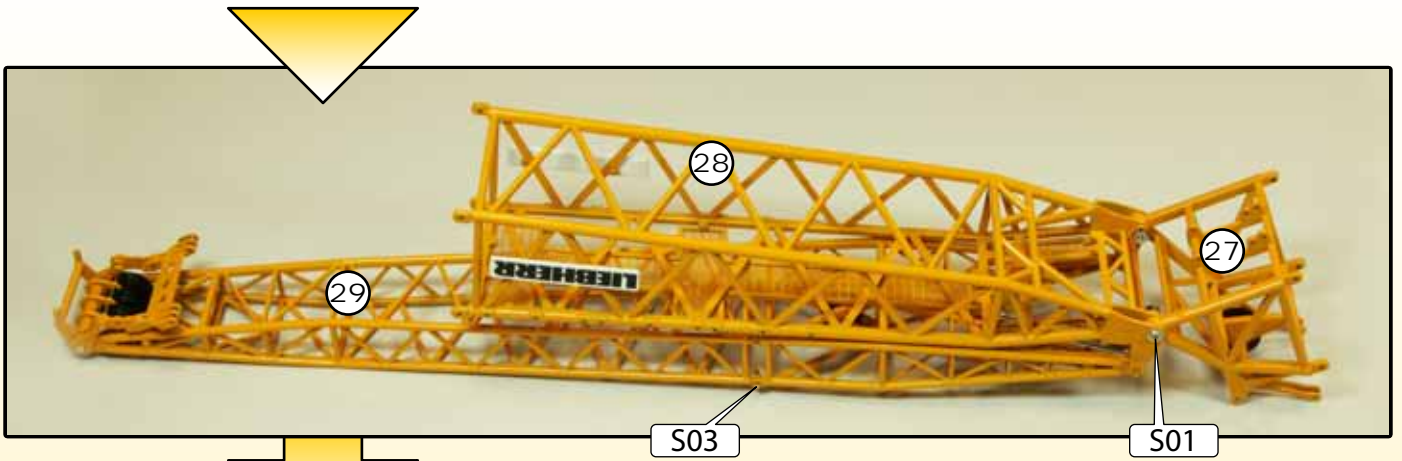

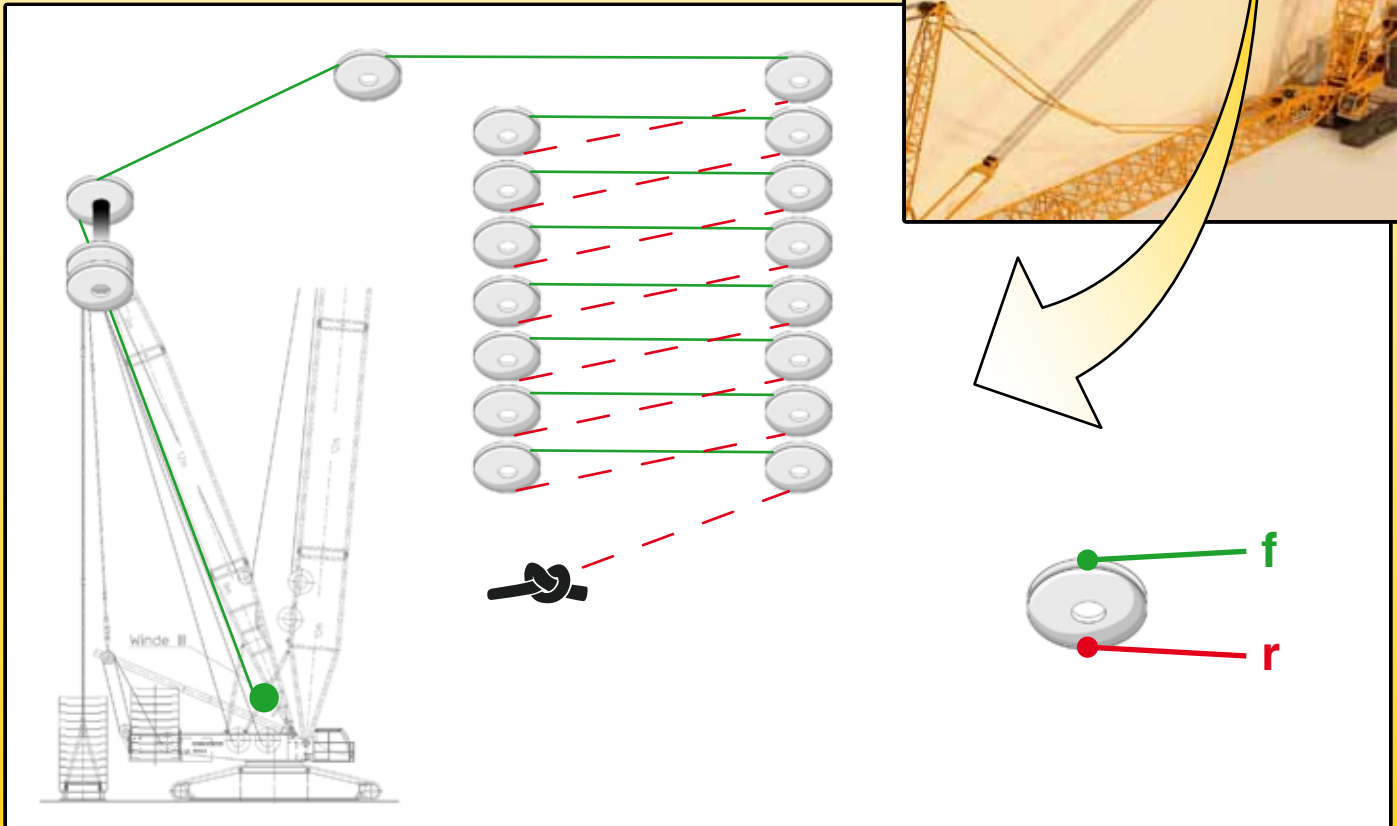
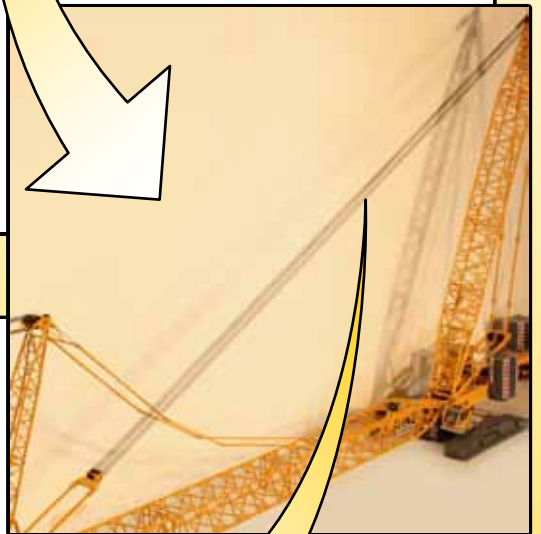
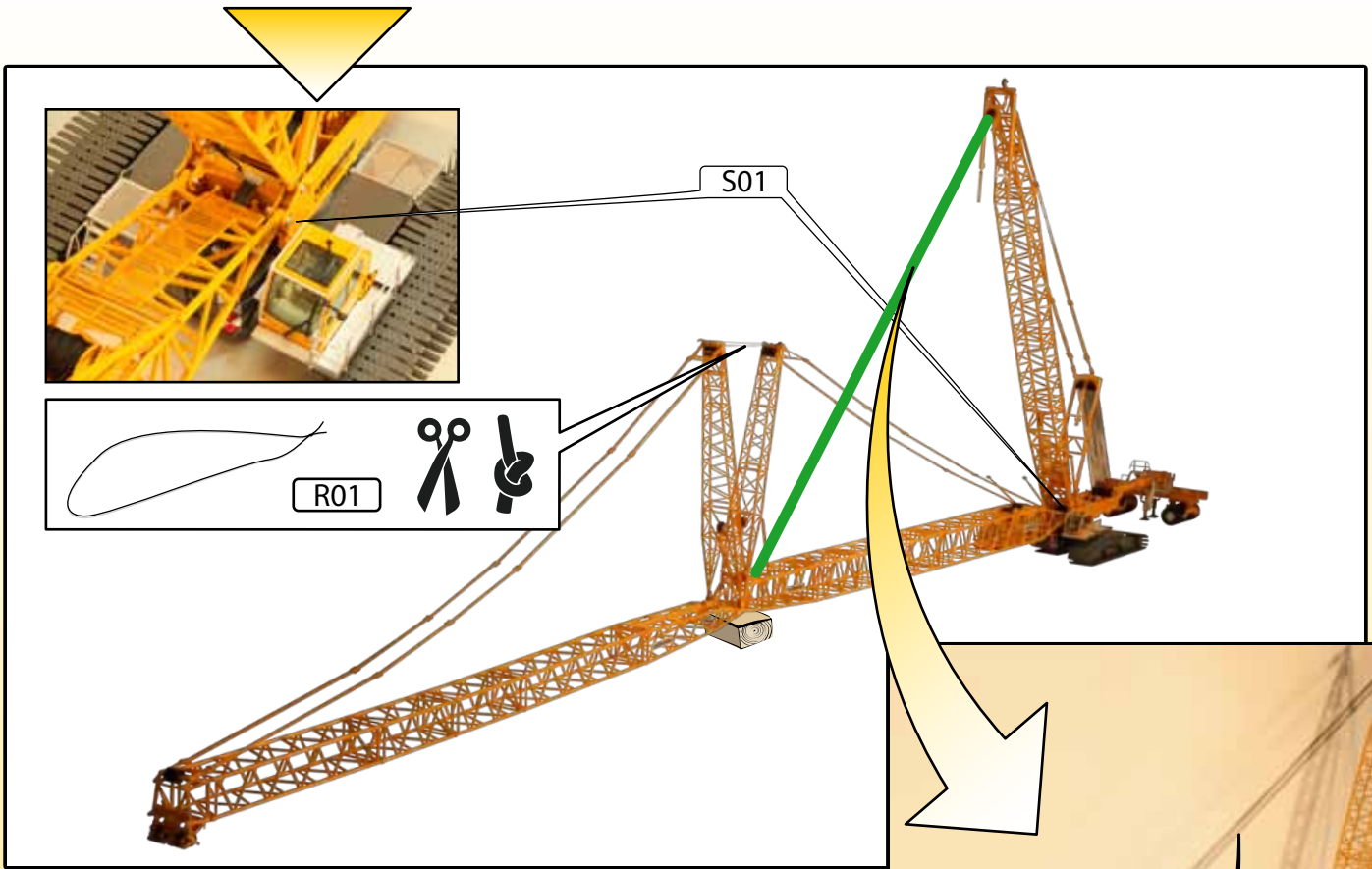

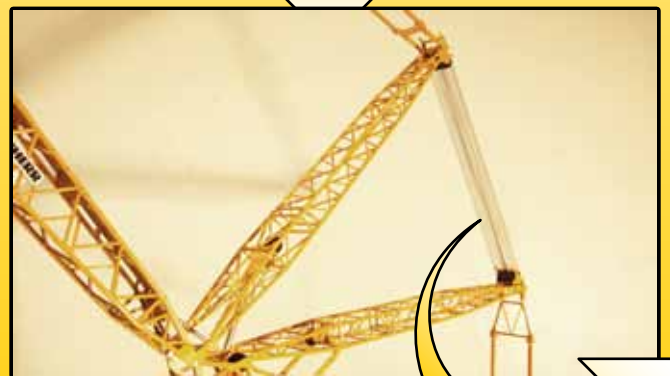
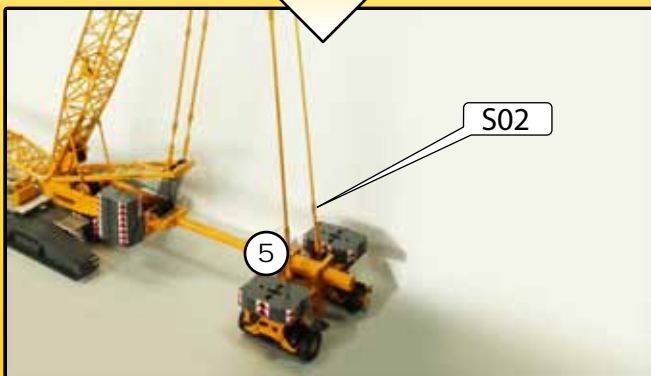
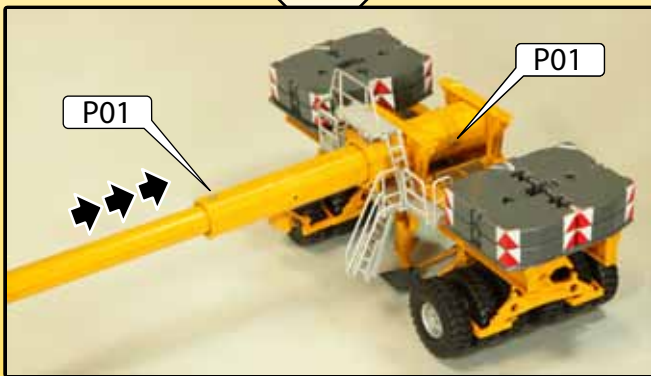
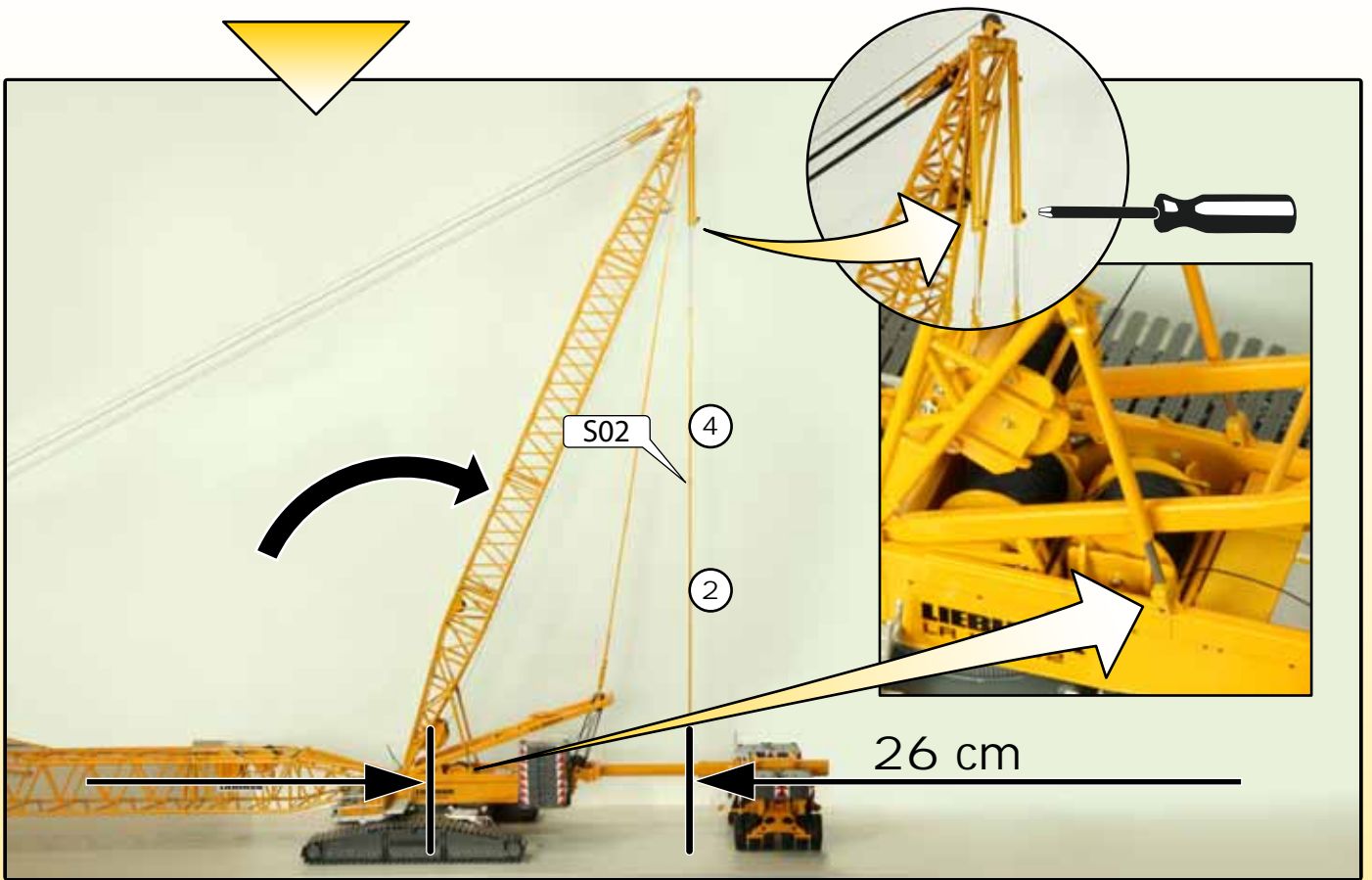

LR 1600/2

LIEBHERR

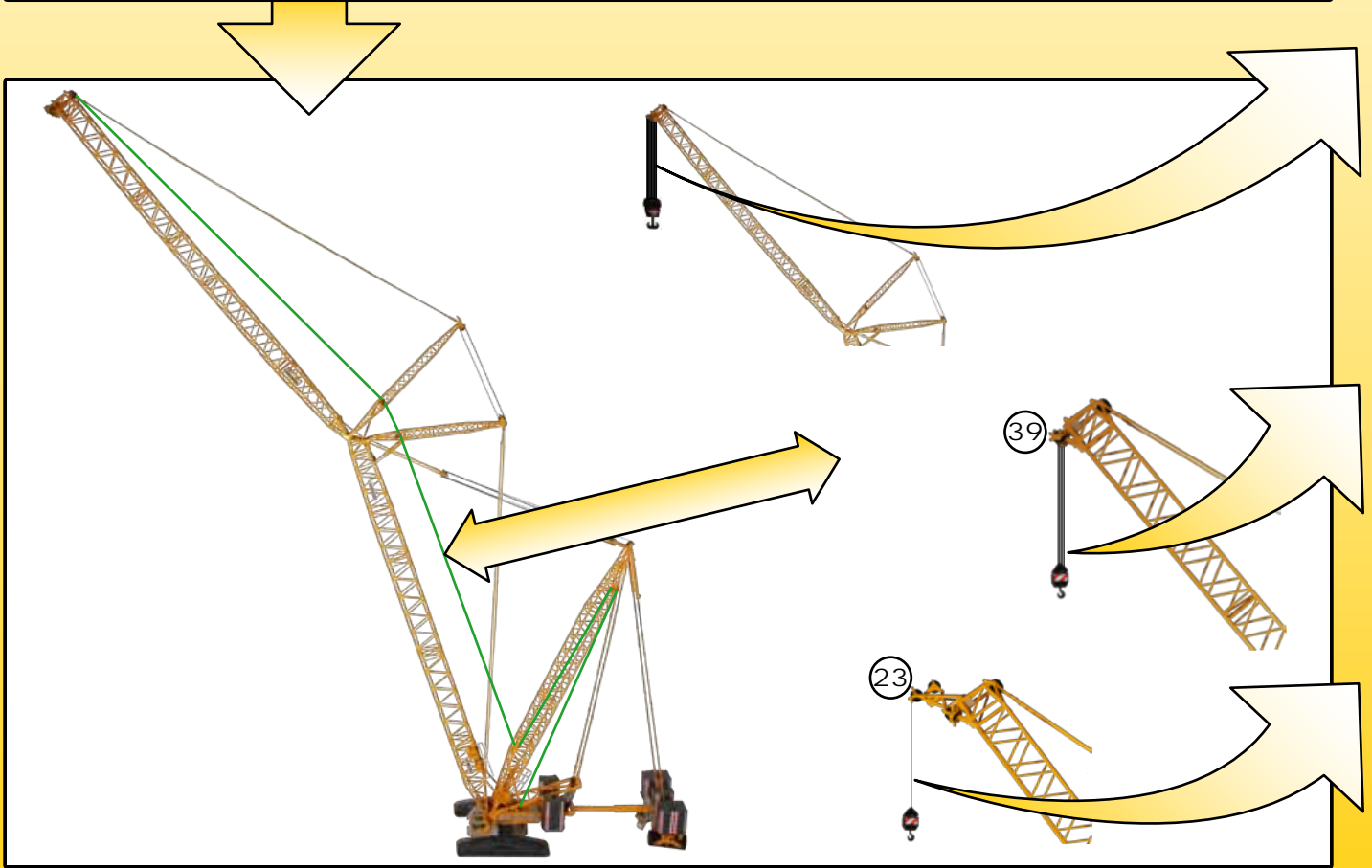
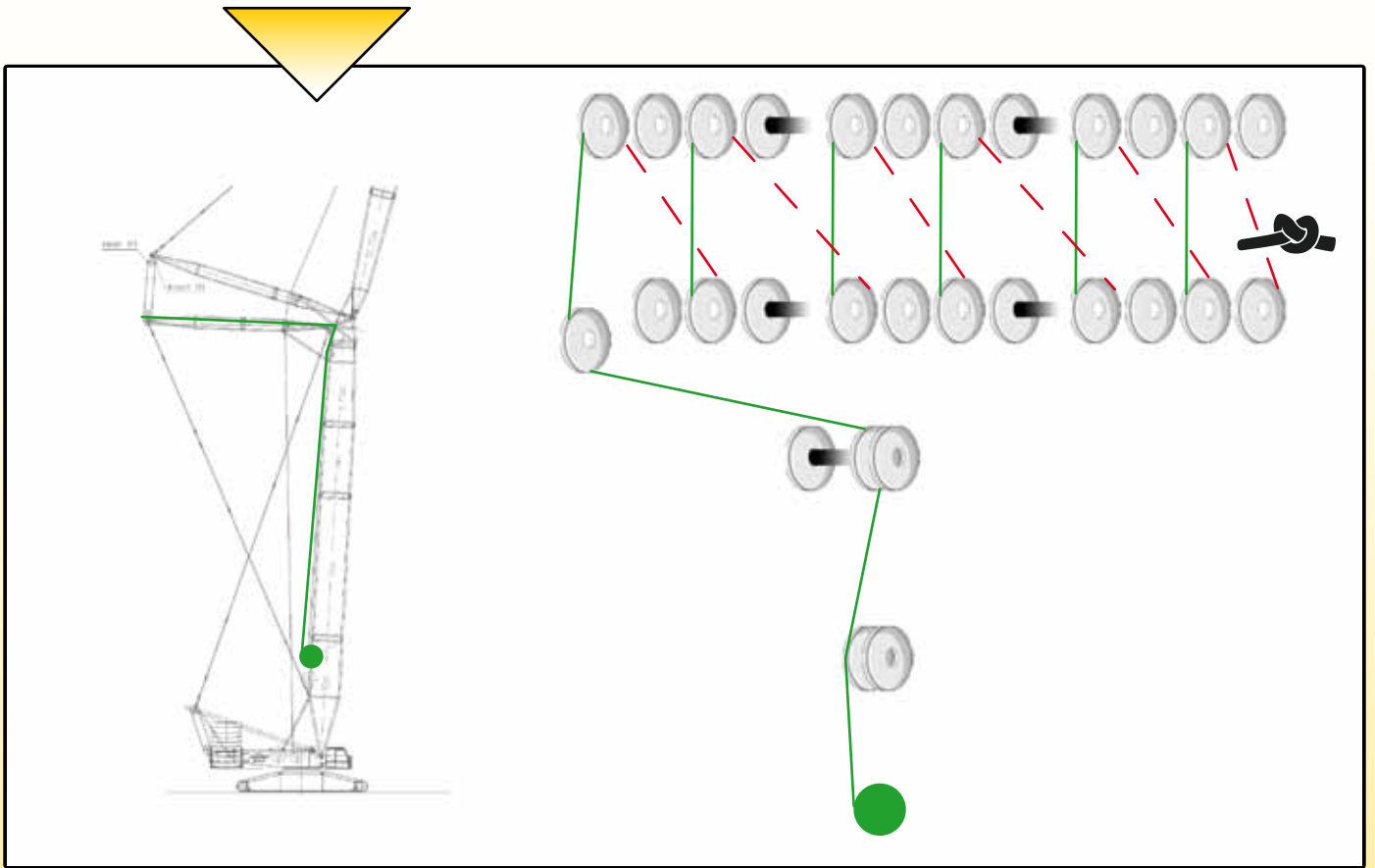

LR 1600/2

LIEBHERR

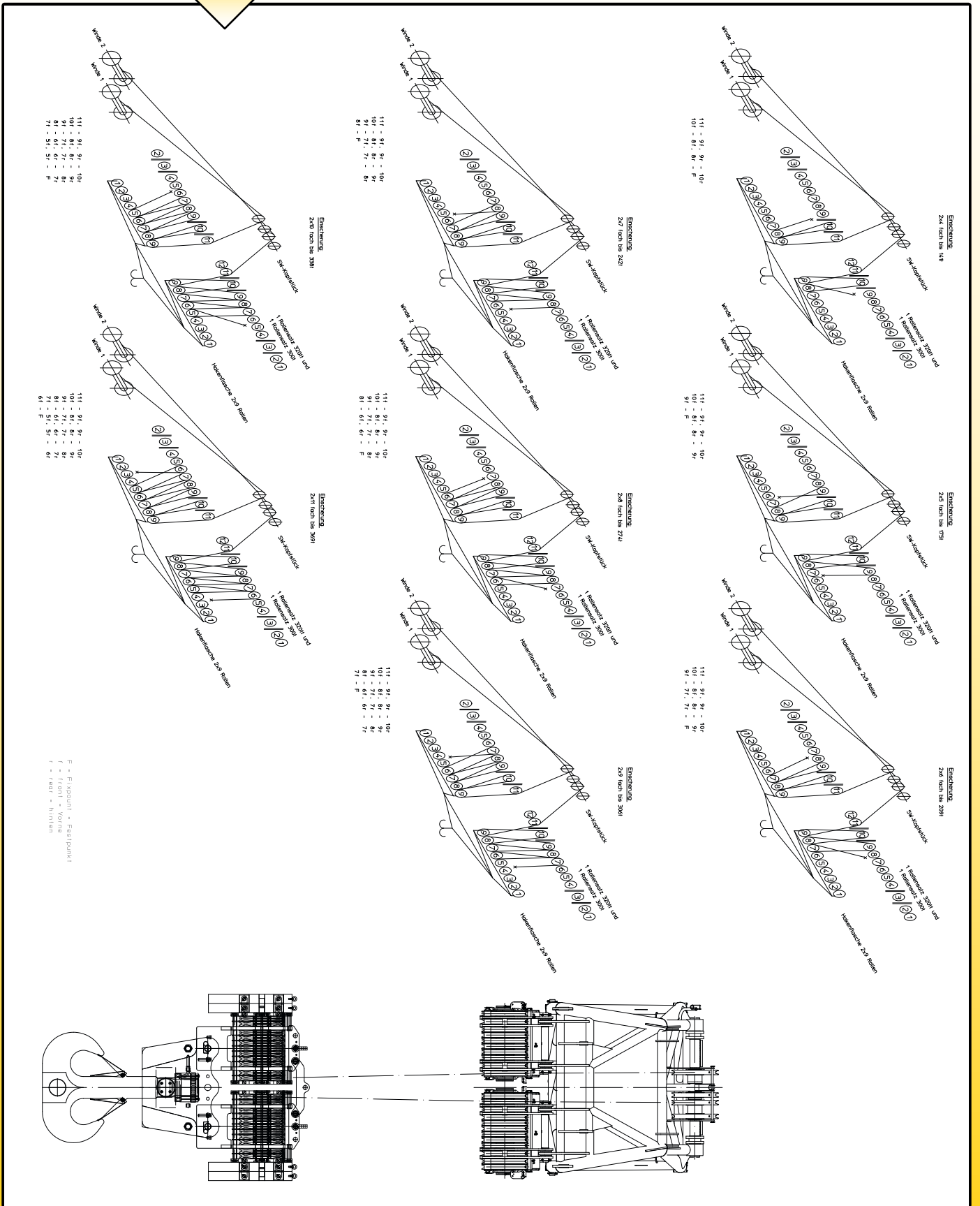
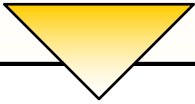

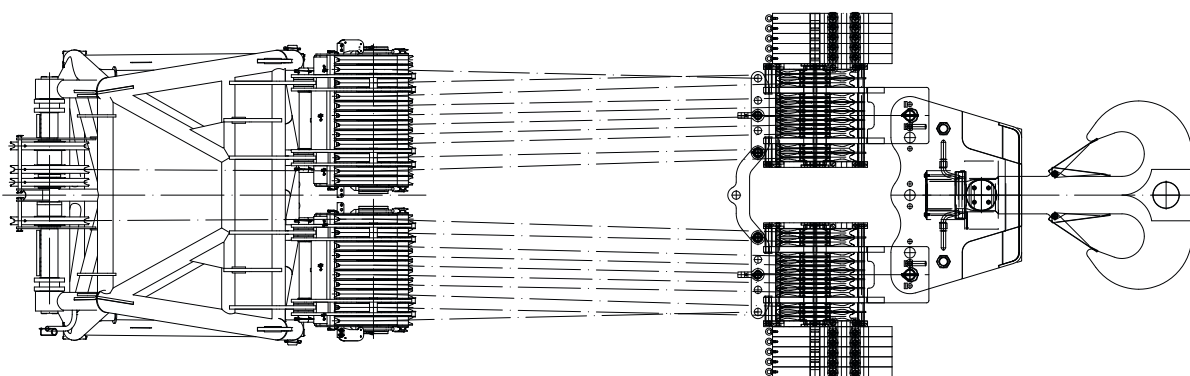
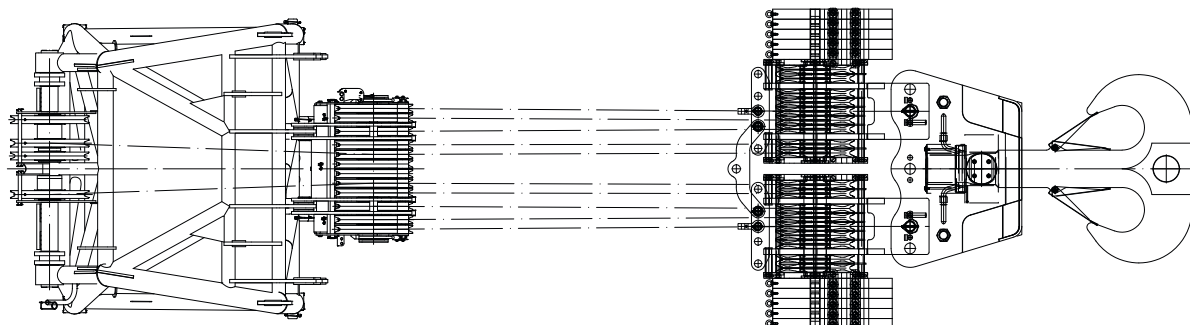
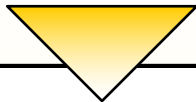

LR 1600/2

LIEBHERR

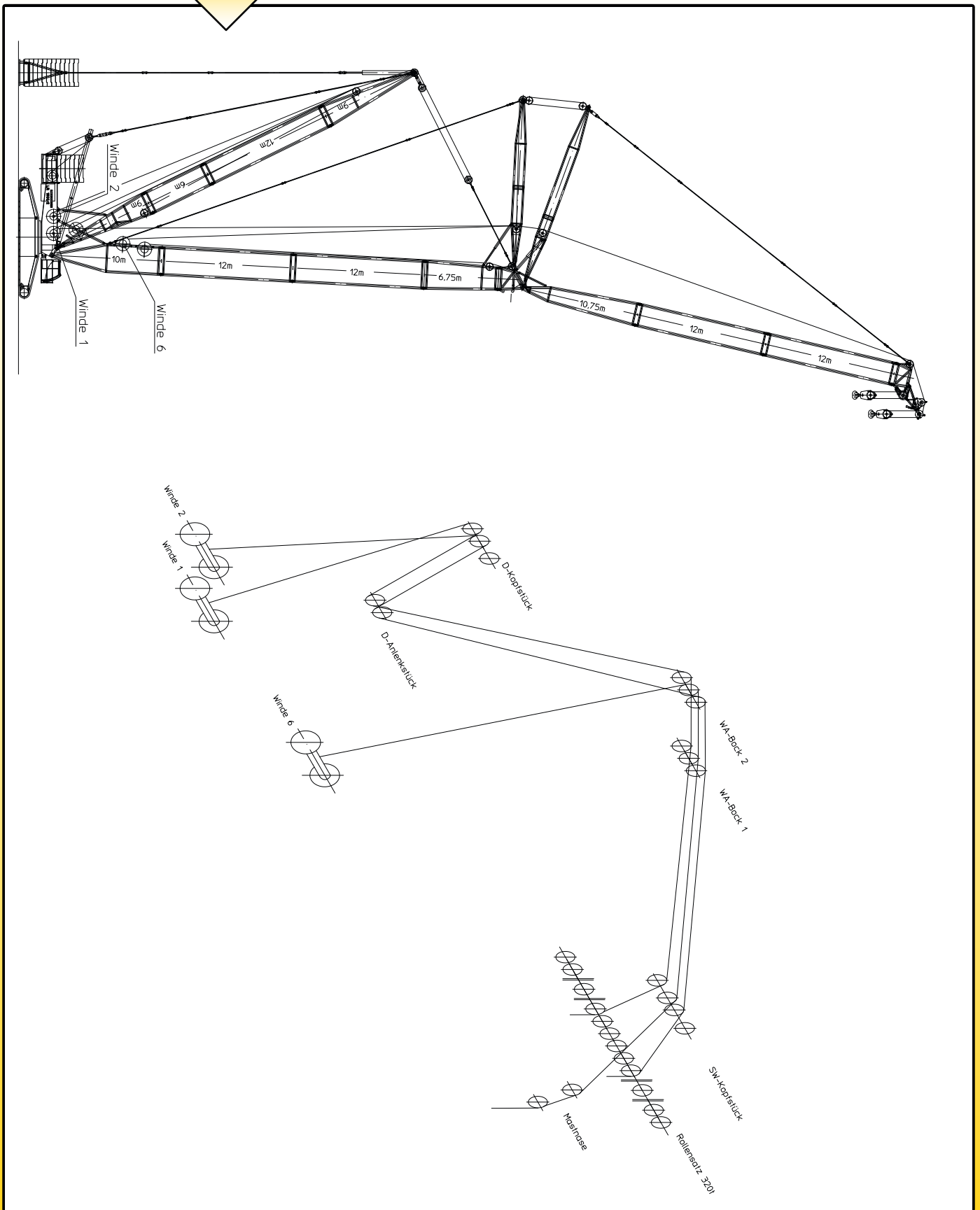

LR 1600/2

LIEBHERR

Weitere Funktionen / Further functions

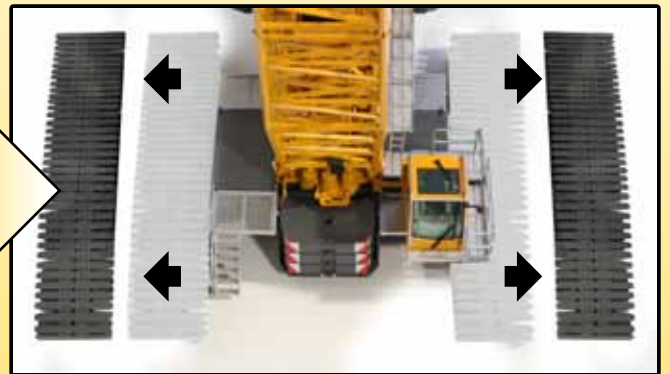
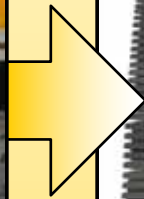
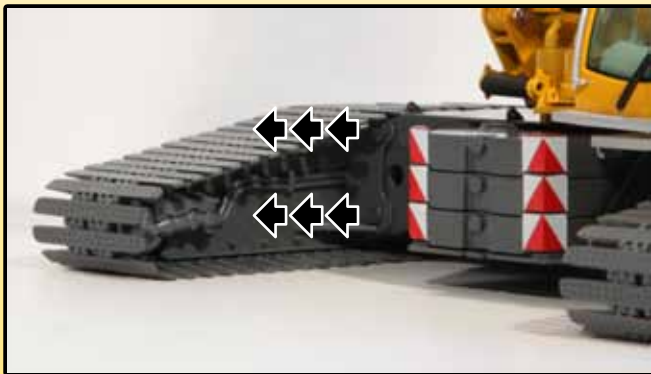
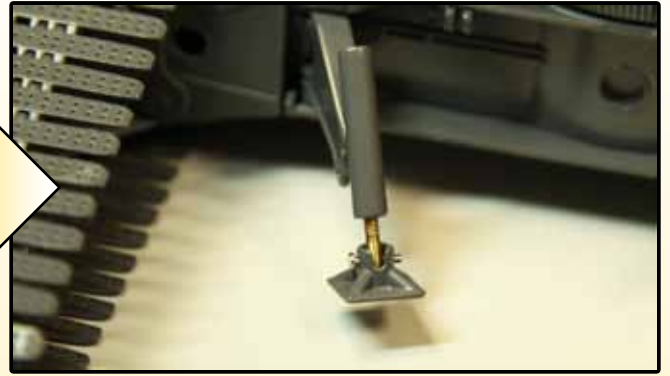
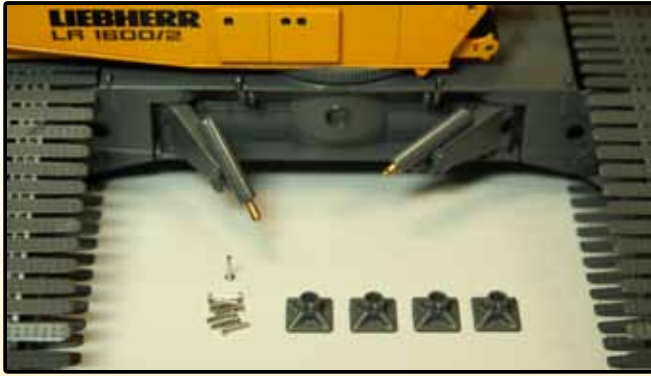

LR 1600/2

LIEBHERR